

PRECISION BALANCES WLC









release date 03-04-2012



Balances series WLC are designed for fast and precise mass determination in laboratory and industrial conditions. They can also be used in areas with no access to mains (230V), as their standard equipment they includes internal rechargeable battery and RS 232 output. WLC series, independently on model (pan size: 128×128, 125×145, 195×195, 290×360 and 400×500 mm) and capacity, features stainless steel weighing platform and backlit LCD display providing good reading of weighing result.



Balances series A2 offer the possibility of weighing loads outside weighing platform (so called under hook weighing), where a load is hanged under the instrument. This is an alternative for weighing loads with non-standard dimensions and shapes.

-  Parts counting
-  Checkweighing
-  Animal weighing
-  Percent setup
-  Caps lock of max indication
-  Measurement in Newton

Technical data:

	WLC 0,6/B1 M	WLC 0,6/A1 M	WLC 1/A2	WLC 2/A2	WLC 6/A2 M	WLC 10/A2	WLC 20/A2
Max capacity	0,6 kg	0,6 kg	1 kg	2 kg	6 kg	10 kg	20 kg
Minimal load	0,5 g	0,5 g	-	-	0,5 g	-	-
Reading unit	0,01 g	0,01 g	0,01 g	0,01 g	0,1 g	0,1 g	0,1 g
Verification unit	0,1 g	0,1 g	-	-	1 g	-	-
Tare range	-0,6 kg	-0,6 kg	-1 kg	-2 kg	-6 kg	-10 kg	-20 kg
Repeatability	0,01 g	0,01 g	0,03 g	0,03 g	0,1 g	0,2 g	0,2 g
Linearity	±0,01 g	±0,01 g	±0,03 g	±0,03 g	±0,1 g	±0,2 g	±0,2 g
Pan size	125 × 145 mm	128 × 128 mm			195 × 195 mm		
OIML class	II	II	-	-	II	-	-
Interface	RS 232						
Power supply	230V / 11V AC or 120V / 11V AC, and accumulator						
IP rating	IP 43						
Stabilization time	3 s						
Working temperature	+15° - +30 °C						
Display	LCD (backlit)						
Net weight/Gross weight	1,2 / 2 kg	2,8 / 3,8 kg			2,8 / 3,8 kg		
Packaging dimensions	320×210×150 mm	440×280×190 mm			440×280×190 mm		

Technical data:

	WLC 6/C1/R WLC 6/C1/K M	WLC 6/12/C1/R WLC 6/12/C1/K	WLC 12/C1/R WLC 12/C1/K	WLC 12/30/C1/R WLC 12/30/C1/K	WLC 30/C1/R WLC 30/C1/K
Max capacity	6 kg	6/12 kg	12 kg	12/30 kg	30 kg
Minimal load	5 g	-	-	-	-
Reading unit	0,1 g	0,1/0,2 g	0,2 g	0,2/0,5 g	0,5 g
Verification unit	1 g	-	-	-	-
Tare range	-6 kg	-12 kg	-12 kg	-30 kg	-30 kg
Repeatability	0,3 g	0,1/0,2 g	0,6 g	0,2/0,5 g	1,5 g
Linearity	±0,3 g	±0,1/0,2 g	±0,6 g	±0,2/0,5 g	±1,5 g
Pan size	290 × 360 mm				
OIML class	II	-	-	-	-
Interface	RS 232				
Power supply	230V / 11V AC or 120V / 11V AC, and accumulator				
Stabilization time	3 s				
Working temperature	+15° - +30 °C				
Display	LCD (backlit)				
Net weight/Gross weight	7 / 8 kg				
Packaging dimensions	550×420×220 mm				

Technical data:

	WLC 60/C2/R WLC 60/C2/K M	WLC 60/120/C2/R WLC 60/120/C2/K	WLC 120/C2/R WLC 120/C2/K
Max capacity	60 kg	60/120 kg	120 kg
Minimal load	50 g	-	-
Reading unit	1 g	1/2 g	2 g
Verification unit	10 g	-	-
Tare range	-60 kg	-120 kg	-120 kg
Repeatability	3 g	1 / 2 g	2 g
Linearity	±3 g	± 1 / 2 g	± 2 g
Pan size		400 × 500 mm	
OIML class	II	-	-
Interface		RS 232	
Power supply	230V / 11V AC or 120V / 11V AC, and accumulator		
Stabilization time	3 s		
Working temperature	+15° - +30 °C		
Display	LCD (backlit)		
Net weight/Gross weight	16 / 18 kg		
Packaging dimensions	720×580×220 mm		

Additional equipment:

"KAFKA" THERMAL PRINTER	ADDITIONAL LCD DISPLAY
IMPACT "EPSON" PRINTER	DENSITY DETERMINATION KIT FOR SOLIDS AND LIQUIDS
RACK FOR UNDER HOOK WEIGHING	EXTERNAL BATTERY PACK WITH CHARGER
SUITCASE FOR BALANCE	COMPUTER SOFTWARE PW-WIN 2005, RAD-KEY 2000, REC-FS 2000

A1 version

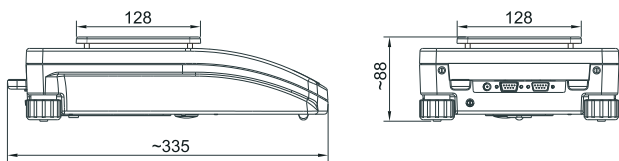

B1 version

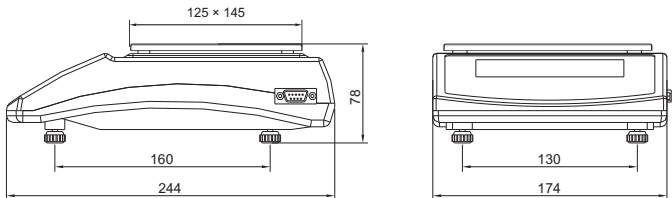

A2 version

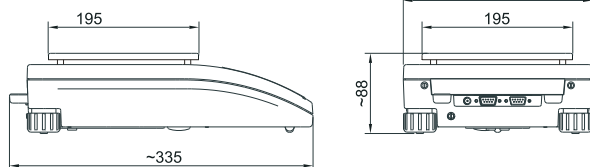

/R version

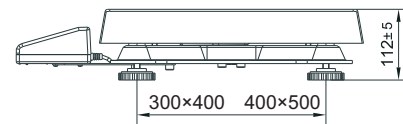

/K version

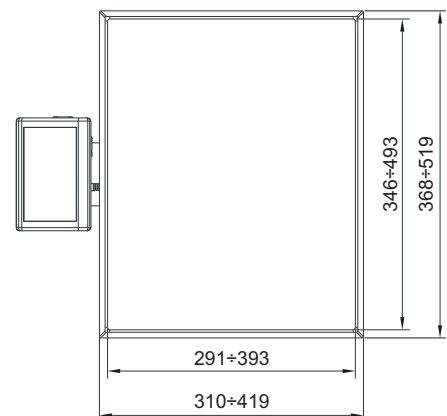
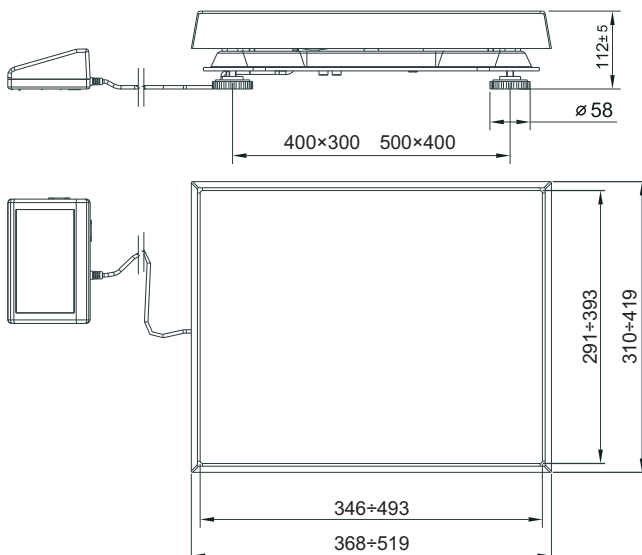

RADWAG

26-600 Radom • 28 Bracka Street • POLAND • Phone: +48 48 3848800 • Fax: +48 48 3850010 • www.radwag.com • e-mail: export@radwag.com